



■ Features

- Constant Voltage PWM style output with frequency 1KHz
- Plastic housing with class II design
- Built-in active PFC function
- No load power consumption < 0.5W (Blank-Type)
- Function options: 2 in 1 dimming (dim-to-off); Auxiliary DC output
- 3 years warranty

■ Applications

- LED strip lighting
- Indoor LED lighting
- LED decorative lighting
- LED architecture lighting

■ Description

IDLV-45 series is a 45W AC/DC LED driver featuring the constant voltage mode PWM style output design. IDLV-45 operates from 90~295VAC and offers models with different rated voltage ranging between 12V and 60V. Thanks to the high efficiency up to 90%, with the fanless design, the entire series is able to operate for -20°C~+85°C case temperature under free air convection. IDLV-45 is equipped with various function options, such as dimming methodologies, so as to provide the design flexibility for LED lighting system.

■ Model Encoding

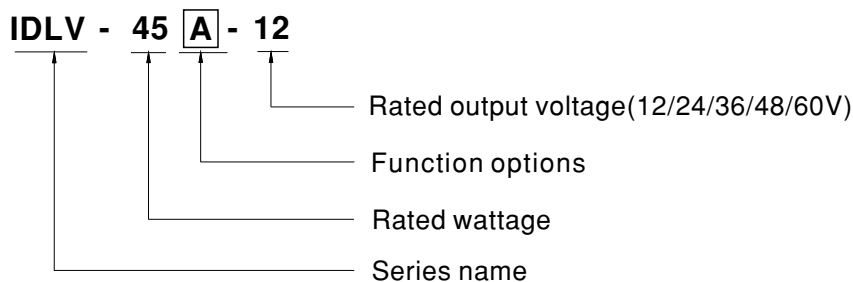

Type	Function	Note
Blank	2 in 1 dimming (0~10VDC and 10V PWM)	In Stock
A	2 in 1 dimming and Auxiliary DC output	In Stock



SPECIFICATION

MODEL		IDLV-45□-12	IDLV-45□-24	IDLV-45□-36	IDLV-45□-48	IDLV-45□-60
OUTPUT	DC VOLTAGE	12V	24V	36V	48V	60V
	RATED CURRENT	3.0A	1.88A	1.25A	0.94A	0.75A
	RATED POWER	36W	45.12W	45W	45.12W	45W
	DIMMING RANGE	0~100%				
	VOLTAGE TOLERANCE	±10%				
	PWM FREQUENCY (Typ.)	1KHz(±20%)				
	SETUP TIME Note.3	500ms / 230VAC 1200ms/115VAC				
	AUXILIARY DC OUTPUT Note.4	Nominal 12V(deviation 11.4~12.6)@50mA for A-Type only				
INPUT	VOLTAGE RANGE Note.2	90 ~ 295VAC 127 ~ 417VDC (Please refer to "STATIC CHARACTERISTIC" section)				
	FREQUENCY RANGE	47 ~ 63Hz				
	POWER FACTOR (Typ.)	PF>0.95/115VAC, PF>0.92/230VAC, PF>0.9/277VAC@full load (Please refer to "POWER FACTOR (PF) CHARACTERISTIC" section)				
	TOTAL HARMONIC DISTORTION	THD< 20%(@load≥60%/115VAC,230VAC; @load≥75%/277VAC) (Please refer to "TOTAL HARMONIC DISTORTION" section)				
	EFFICIENCY (Typ.)	84%	86%	88%	88%	90%
	AC CURRENT (Typ.)	0.6A / 115VAC 0.4A / 230VAC 0.3A / 277VAC				
	INRUSH CURRENT(Typ.)	COLD START 30A(twidth=100μs measured at 50% Ipeak) at 230VAC; Per NEMA 410				
	MAX. No. of PSUs on 16A CIRCUIT BREAKER	32 units (circuit breaker of type B) / 32 units (circuit breaker of type C) at 230VAC				
	LEAKAGE CURRENT	<0.75mA / 277VAC				
	NO LOAD POWER CONSUMPTION	<0.5W for Blank-Type, <1.2W for A-Type				
PROTECTION	SHORT CIRCUIT	Shut down O/P voltage, re-power on to recovery				
	OVER CURRENT	105 ~ 115% Protection type : Hiccup mode, recovers automatically after fault condition is removed				
ENVIRONMENT	WORKING TEMP.	Tcase=-20 ~ +85°C (Please refer to " OUTPUT LOAD vs TEMPERATURE" section)				
	MAX. CASE TEMP.	Tcase=+85°C				
	WORKING HUMIDITY	20 ~ 90% RH non-condensing				
	STORAGE TEMP., HUMIDITY	-40 ~ +80°C, 10 ~ 95% RH				
	TEMP. COEFFICIENT	±0.03%/°C (0 ~ 40°C)				
	VIBRATION	10 ~ 500Hz, 2G 10min./1cycle, period for 60min. each along X, Y, Z axes				
SAFETY & EMC	SAFETY STANDARDS	UL8750,CSA C22.2 NO.250.13-12;ENEC EN61347-1 & EN61347-2-13 independent, EN62384,GB19510.1,GB19510.14 approved				
	WITHSTAND VOLTAGE	I/P-O/P:3.75KVAC				
	ISOLATION RESISTANCE	I/P-O/P:100M Ohms / 500VDC / 25°C/ 70% RH				
	EMC EMISSION	Compliance to EN55015, EN61000-3-2 Class C (@load ≥ 60%) ; EN61000-3-3,GB17743,GB17625.1				
	EMC IMMUNITY	Compliance to EN61000-4-2,3,4,5,6,8,11; EN61547, light industry level(surge immunity:Line-Line:1KV)				
OTHERS	MTBF	386.59Khrs min. MIL-HDBK-217F (25°C)				
	DIMENSION	120*75*25mm (L*W*H)				
	PACKING	0.22Kg;54pcs/13Kg/ 0.93CUFT				
NOTE	<ol style="list-style-type: none"> All parameters NOT specially mentioned are measured at 230VAC input, rated current and 25°C of ambient temperature. De-rating may be needed under low input voltages. Please refer to "STATIC CHARACTERISTIC" sections for details. Length of set up time is measured at cold first start. Turning ON/OFF the driver may lead to increase of the set up time. There is no design of short circuit protection for the Auxiliary DC output; this function can not be used when dimming input terminals(DIM+,DIM-) are short circuit or when it is no load or short circuit at output(Vo+,Vo-). The driver is considered as a component that will be operated in combination with final equipment. Since EMC performance will be affected by the complete installation, the final equipment manufacturers must re-qualify EMC Directive on the complete installation again. 					

■ DIMMING OPERATION

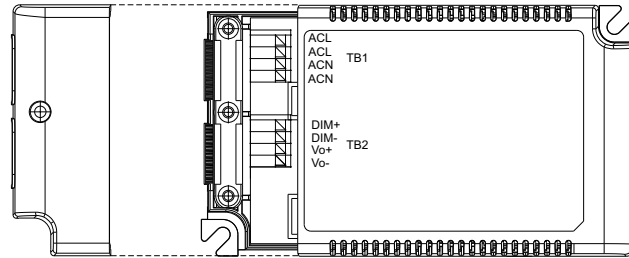

※ **Dimming principle for PWM style output**

Dimming is achieved by varying the duty cycle of the output current.

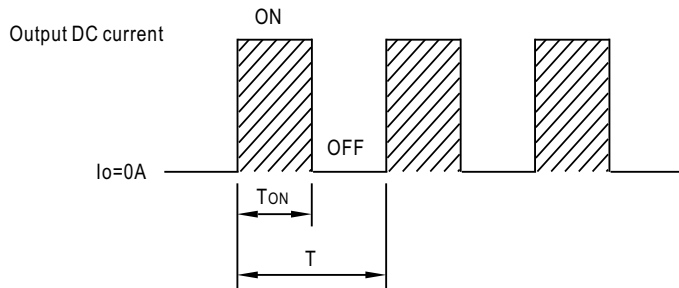

$$\text{Duty cycle(\%)} = \frac{T_{\text{ON}}}{T} \times 100\%$$

Output PWM frequency : 1KHz(±20%)

※ **2 in 1 dimming function**

◎ Applying additive 0 ~ 10VDC

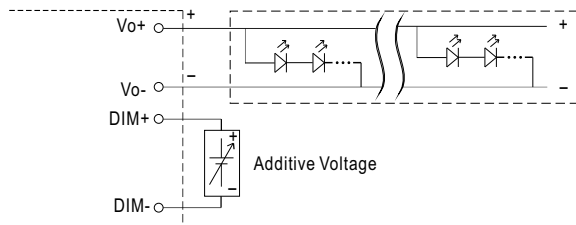

“DO NOT connect "DIM- to Vo-”

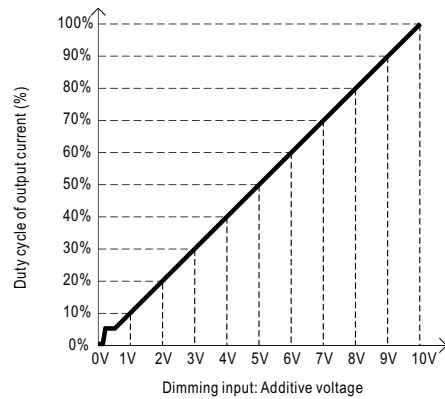

◎ Applying additive 10V PWM signal (frequency range 300~3000Hz):

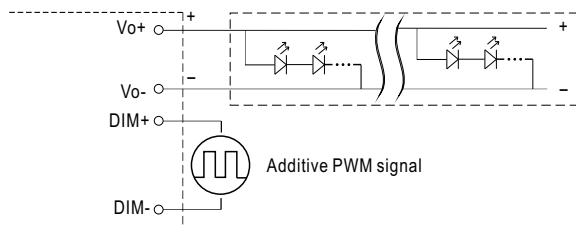

“DO NOT connect "DIM- to Vo-”

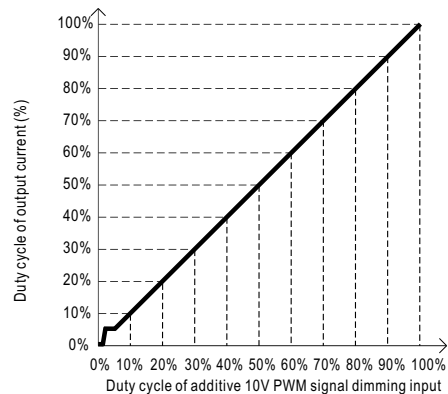

Note : 1. Min. duty cycle of output current is about 8% and the output current is not defined when 0% < I_{out} < 8%.
 2. The duty cycle of output current could drop down to 0% when dimming input is about 0Vdc or 10V PWM signal with 0% duty cycle.

OUTPUT LOAD vs TEMPERATURE

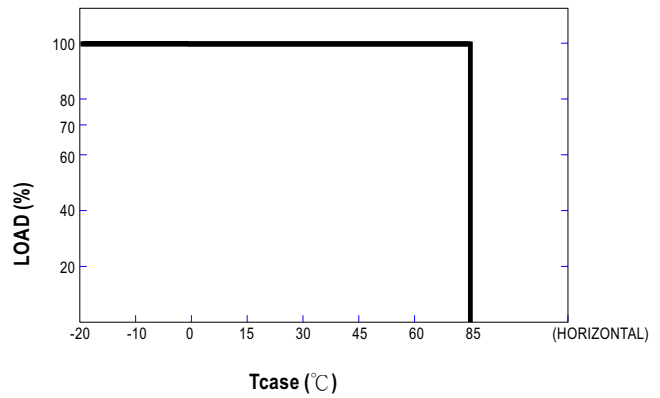
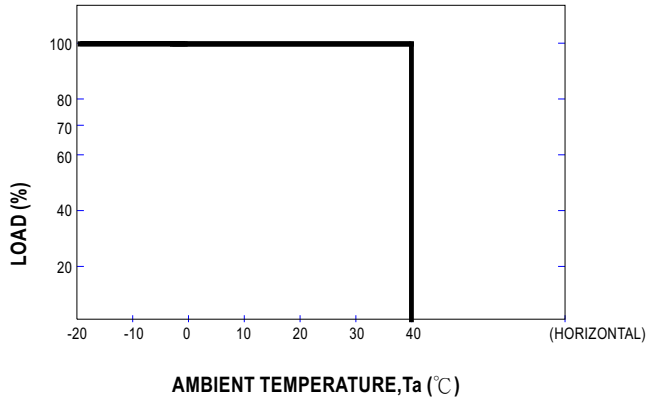

STATIC CHARACTERISTIC

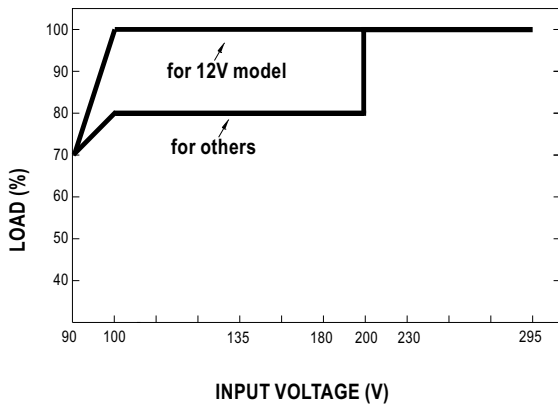

※ De-rating is needed under low input voltage.

POWER FACTOR (PF) CHARACTERISTIC

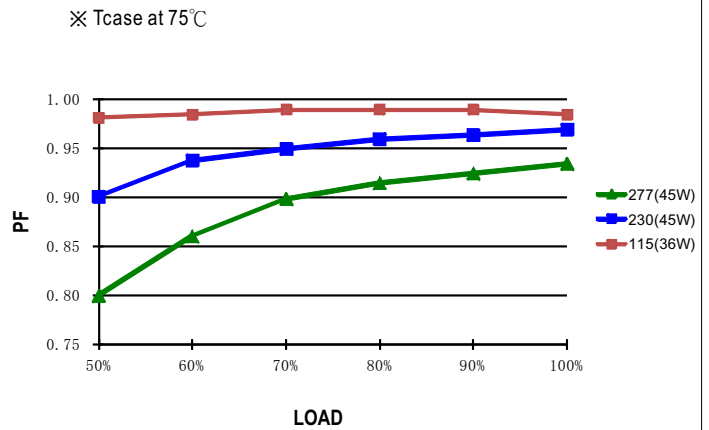

TOTAL HARMONIC DISTORTION (THD)

※ 60V Model, T_{case} at 75°C

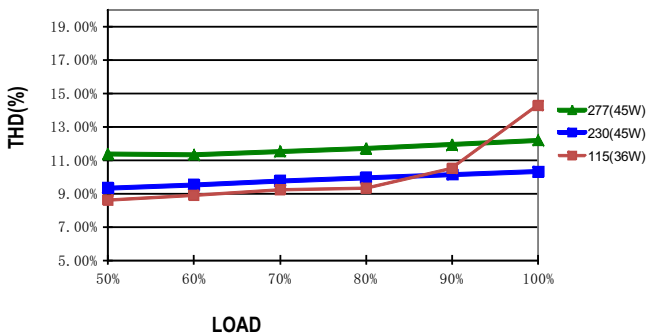

EFFICIENCY vs LOAD

IDLV-45 series possess superior working efficiency that up to 90% can be reached in field applications.

※ 60V Model, T_{case} at 75°C

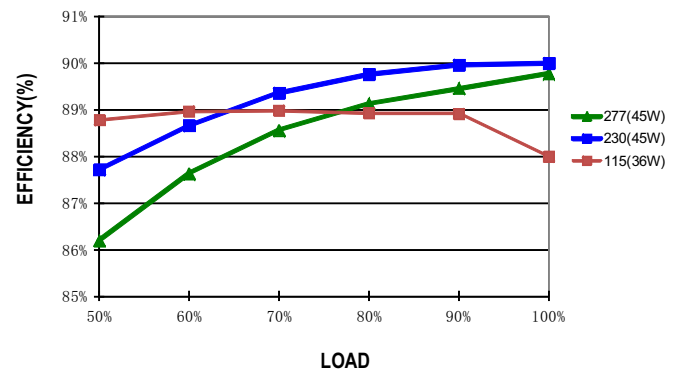

■ BLOCK DIAGRAM

fosc : 70~150KHz

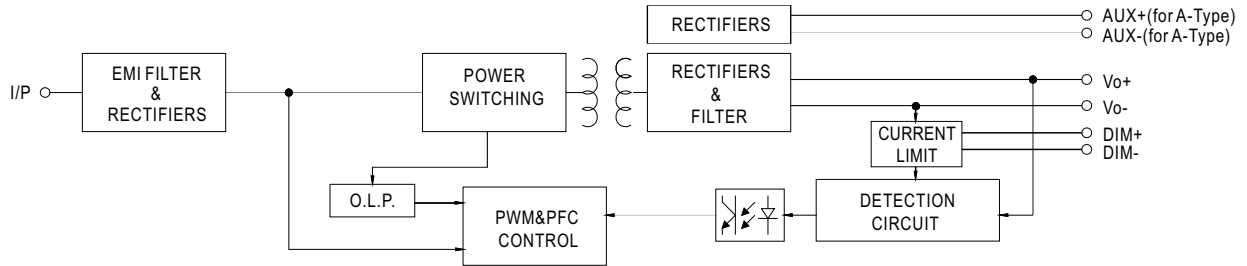

■ MECHANICAL SPECIFICATION

※ Blank-Type

Case No.IDLV-45A Unit:mm

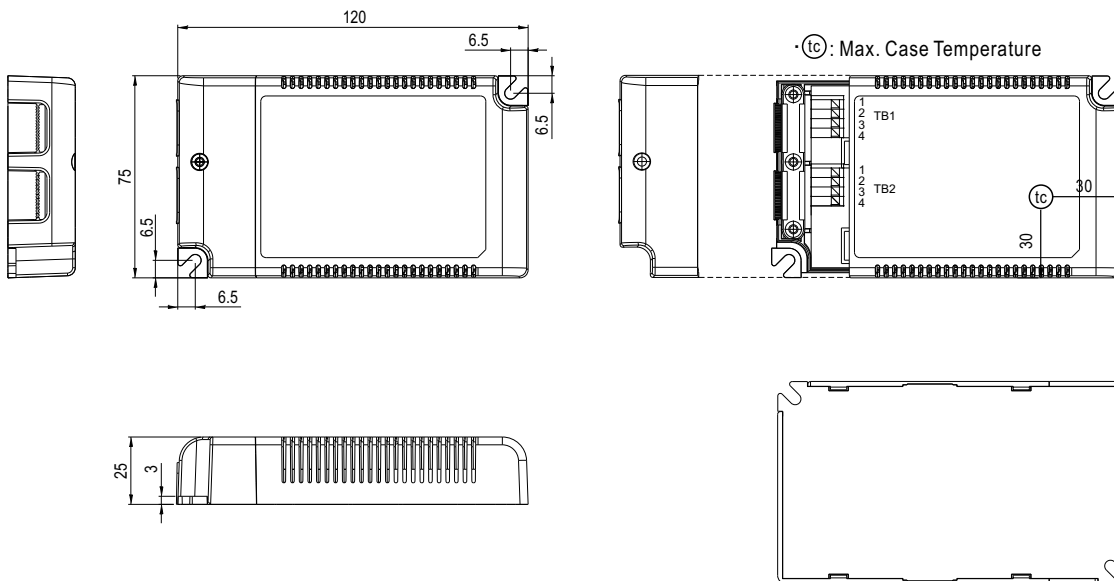

Terminal Pin No. Assignment(TB1)

Pin No.	Assignment
1	ACL
2	ACL
3	ACN
4	ACN

Terminal Pin No. Assignment(TB2)

Pin No.	Assignment
1	DIM+
2	DIM-
3	Vo+
4	Vo-

※ A-Type

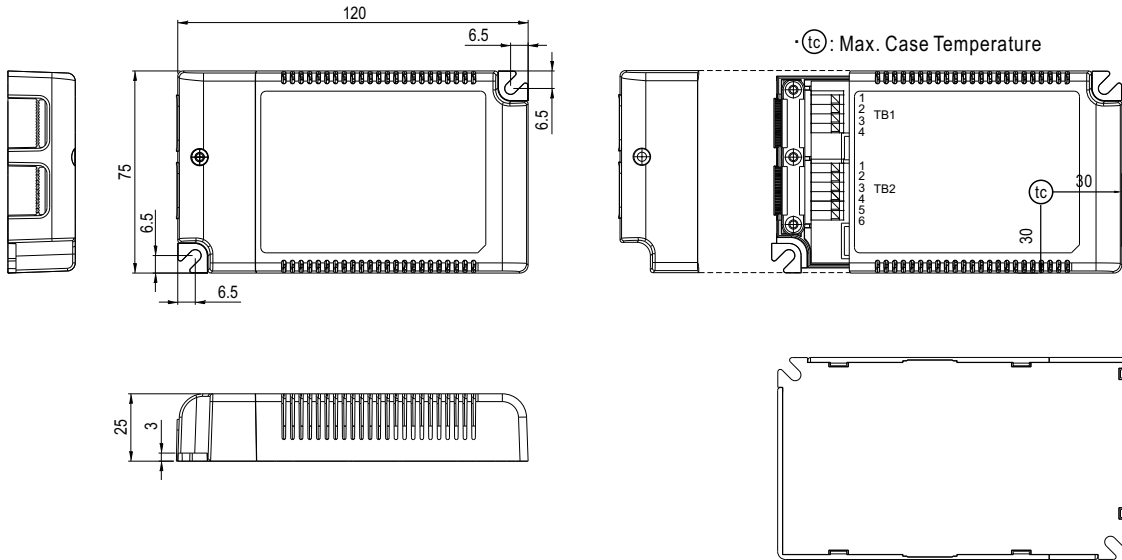

Terminal Pin No. Assignment(TB1)

Pin No.	Assignment
1	ACL
2	ACL
3	ACN
4	ACN

Terminal Pin No. Assignment(TB2)

Pin No.	Assignment	Pin No.	Assignment
1	DIM+	4	Vo-
2	DIM-	5	AUX+
3	Vo+	6	AUX-

■ INSTALLATION MANUAL

Please refer to : <http://www.meanwell.com/manual.html>